

# Performance Comparison between ĆUK and SEPIC Converters for Maximum Power Point Tracking Using Incremental Conductance Technique in Solar Power Applications

James Dunia, Bakari M. M. Mwinyiwiwa

**Abstract**—Photovoltaic (PV) energy is one of the most important energy resources since it is clean, pollution free, and endless. Maximum Power Point Tracking (MPPT) is used in photovoltaic (PV) systems to maximize the photovoltaic output power, irrespective the variations of temperature and radiation conditions. This paper presents a comparison between Ćuk and SEPIC converter in maximum power point tracking (MPPT) of photovoltaic (PV) system. In the paper, advantages and disadvantages of both converters are described. Incremental conductance control method has been used as maximum power point tracking (MPPT) algorithm. The two converters and MPPT algorithm were modelled using MATLAB/Simulink software for simulation. Simulation results show that both Ćuk and SEPIC converters can track the maximum power point with some minor variations.

**Keywords**—Ćuk Converter, Incremental Conductance, Maximum Power Point Tracking, PV Module, SEPIC Converter.

## I. INTRODUCTION

THE electrical energy supplied by fossil fuel is not enough to meet all the peoples' demand while all human beings need electricity for sustainable development and poverty reduction. The world primary energy demand is expected to increase by 1.7% per year from the year 2002 and expanding to more than 50% in 2030 [4]. The energy source which the society can depend on is renewable energy since it is clean, pollution free, and endless. PV system is one of power generations that utilize renewable energy (solar energy). To reduce consumption of conventional energy, then the PV system must be connected to grid, either directly or through back-up battery bank [4]. However, the PV system has low efficiency because of the power generated from PV systems depends on the irradiation and temperature variation. To improve the efficiency of PV system Maximum Power Point Tracking charger control system is employed so that to extract maximum energy from the PV system.

There are many MPPT algorithms such as Perturb and Observe, Incremental Conductance method, Fractional short circuit current, Fractional open circuit voltage, neural networks and Fuzzy logic [1], [3]. Perturb and Observe method has problem to determine the optimal operating point

in rapid changes of sun irradiance but it is easier and very reliable in normal condition [2], [5].

Boost converter is commonly used as a MPPT device. But the input voltage of the boost converter must be smaller than the desired output voltage [6], [7]. This paper focuses on comparing the use of Ćuk and SEPC dc-dc converter as voltage level control using Incremental conductance MPPT systems.

Solar power is an alternative energy source that will hopefully lead the society away from Petroleum dependent energy sources. The major problem with the existing solar energy harvesting technologies is that, the efficiencies of solar power systems are still very low and the costs per kilo-Watt-hour (kWh) are not competitive as compared to petroleum energy sources. One of the most difficult parts of designing Maximum Power Point Tracking charger controller is dc-dc converter. MPPT technique without proper design of dc-dc converter cannot track the maximum output power operating point.

## II. OVERVIEW OF PHOVOLTAIC SYSTEM

### A. Photovoltaic Module

Photovoltaic (PV) module is a type of equipment used to convert sunlight into electrical energy. It is formed by combination of many solar cell connected in series and in parallel according to the required amount of current and voltage. As sunlight strikes a solar cell, the incident energy is converted directly into electrical energy without any mechanical effort.

### B. Equivalent Circuit of PV Module

Considering a model of single diode, then a solar cell is configured as shown in Fig. 1. This model offers a good compromise between simplicity and accuracy with the basic structure consisting of a current source and a parallel diode, whereby  $I_{ph}$  represents the cell photocurrent while  $R_{sh}$  and  $R_s$  are, respectively, the intrinsic shunt and series resistances of the cell [1].

James Dunia and Bakari M. M. Mwinyiwiwa are with the Department of Electrical Engineering, College of Engineering and Technology, University of Dar es Salaam, Dar es Salaam, Tanzania (corresponding author to provide e-mail: bakari\_mwinyiwiwa@yahoo.com).

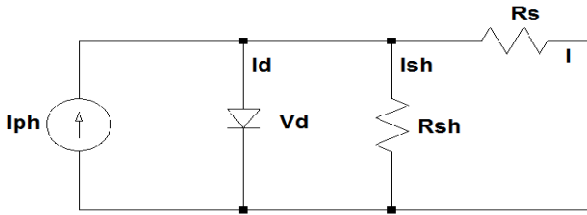

Fig. 1 Schematic diagram of single diode solar cell

### C. Equations of a PV Cell

PV cells are grouped in larger units called PV modules, which are further interconnected in a series and in parallel configuration to form PV arrays. The following are the basic equations from the theory of semiconductors and photovoltaic that mathematically describe the I-V characteristic of the photovoltaic cell and module [1].

### D. Photo Current

The PV cell photocurrent  $I_{ph}$  depends linearly on the solar irradiation and it is also influenced by the temperature according to (1).

$$I_{ph} = [I_{sc} + K_1 (T_c - T_{ref})] * H \quad (1)$$

where  $I_{ph}$  is the nominal generated current at  $25^{\circ}C$  and  $1kW/m^2$ ;  $I_{sc}$  is the cell's short-circuit current at  $25^{\circ}C$  and  $1kW/m^2$ ,  $K_1$  is the cell's short-circuit current per temperature coefficient ( $0.0017A/K$ ),  $T_{ref}$  is the cell's reference temperature, and  $H$  is the solar insolation in  $kW/m^2$ .

### E. PV Module Reverse Saturation Current

PV module reverse saturation current,  $I_{rs}$ , is given by

$$I_{rs} = \frac{I_{sc}}{\left[ \exp\left(\frac{qV_{OC}}{N_s k A T}\right) - 1 \right]} \quad (2)$$

where  $q$  is the electron charge ( $1.6 \times 10^{-19}C$ ),  $V_{oc}$  is the PV module open-circuit voltage ( $22.3V$ ),  $N_s$  is the number of cells connected in series (36),  $k$  is the Boltzmann constant ( $1.3805 \times 10^{-23} J/K$ ),  $A$  is the ideal factor (1.6).

### F. PV Module Saturation Current

The PV module saturation current  $I_0$  varies with the cell temperature and is given by (3). Where:  $E_{go}$  is the band gap energy of the semiconductor ( $E_{go} \approx 1.1eV$  for the polycrystalline Si at  $25^{\circ}C$ ).

$$I_0 = I_{rs} * \left(\frac{T}{T_r}\right)^3 * \exp\left[\left(\frac{q * E_{go}}{A * k}\right) * \left(\left(\frac{1}{T_r}\right) - \left(\frac{1}{T}\right)\right)\right] \quad (3)$$

### G. Module Output Current $I_{PV}$

The basic equation that describes the current output of the PV module  $I_{PV}$  of single diode model presented in Fig. 1 is given by (4).

$$I_{PV} = N_p * I_{ph} - N_p * I_0 \left[ \exp\left(\frac{q * (V_{pv} + I_{pv} * R_s * R_s)}{N_s * A * k * T}\right) - 1 \right] - \frac{V_{pv} + (I_{pv} * R_s)}{R_{sh}} \quad (4)$$

where  $N_p$  is the number of parallel connection of cell ( for referred module  $N_p = 1$ ),  $N_s$  is the number of series connections of cells (for referred module  $N_s = 36$ ),  $V_{PV} = V_{oc}$  is open circuit voltage =  $22.3V$ ,  $R_s$  is the equivalent series resistance of the module,  $R_{sh}$  is the equivalent parallel resistance.

The effect of parallel resistance, when it is sufficiently small, is to reduce the open-circuit voltage and the fill factor [3]. The short-circuit current is not affected by  $R_{sh}$ .

The value of parallel resistance  $R_{sh}$  is generally high and hence neglected to simplify the model as given by (5). The series resistance  $R_s$  (about  $0.1\Omega$ ) is the sum of several structural resistances of the PV module and its influence is stronger especially near the maximum power point region. Equation (4) for the current output of PV module can be simplified as shown by (5).

$$I_{PV} = N_p * I_{ph} - N_p * I_0 \left[ \exp\left(\frac{q * (V_{pv} + I_{pv} * R_s * R_s)}{N_s * A * k * T}\right) - 1 \right] \quad (5)$$

In this paper, the photovoltaic module BP-583F panel has been used and specifications are listed in Table I.

TABLE I  
PV PANEL ELECTRICAL SPECIFICATIONS

Electrical Parameter	Value
Maximum Power (Pmax)	75.5 W
Voltage at Pmax (Vmp)	17 V
Current at Pmax (Imp)	4.5 A
Open-circuit voltage (Voc)	22.3 V
Short-circuit current (Isc)	5 A

## III. MAXIMUM POWER POINT TRACKING (MPPT)

### A. MPPT Charger Control

Maximum Power Point Tracking, frequently referred to as MPPT, is an algorithm that includes electronic system to operate the Photovoltaic (PV) modules in a manner that allows the modules to produce all the power they are capable of. MPPT is not a mechanical tracking system; it is fully electronic system that varies the electrical operating point of the modules so that the modules are able to deliver maximum available power at available irradiation.

### B. MPPT Techniques

Maximum Power Point Tracking (MPPT) technique is used to improve the efficiency of the solar panel. According to Maximum Power Transfer theorem, the power output of a circuit is maximum when the Thevenin impedance of the circuit (source impedance) matches with the load impedance.

There are different techniques used to track maximum power point. Few of the most popular techniques are: perturb and observe, incremental conductance, fractional short circuit current, fractional open circuit voltage, neural Networks and fuzzy logic. The choice of the algorithm depends on the complexity and time the algorithm takes to track the MPP and implementation cost. In this paper incremental conductance technique has been used.

#### IV. INCREMENTAL CONDUCTANCE TECHNIQUE MPPT

In incremental conductance technique the array terminal voltage is always adjusted according to the MPP voltage, it is based on the incremental conductance and instantaneous conductance of the PV module. Fig. 2 shows that the slope of the P-V array power curve is zero at the MPP, increasing on the left of the MPP and decreasing on the right of the MPP.

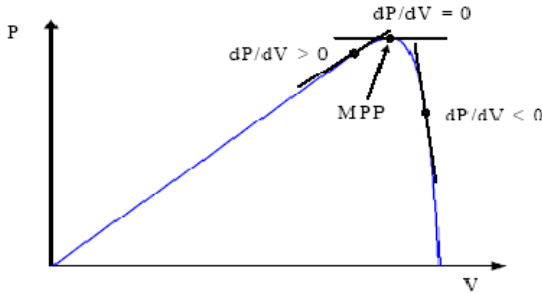

Fig. 2 Basic idea of incremental conductance method on a P-V Curve of solar module

The basic equations of incremental conductance method of MPPT technique are given by (6), (7) and (8).

At MPPT then

$$\frac{dI}{dV} = -\frac{I}{V} \quad (6)$$

on the left of MPPT we have

$$\frac{dI}{dV} > -\frac{I}{V} \quad (7)$$

and on the Right of MPPT we have

$$\frac{dI}{dV} < -\frac{I}{V} \quad (8)$$

where I and V are PV module output current and voltage respectively. The left hand side of (6) through (8) represents incremental conductance of PV module and the right hand side represents the instantaneous conductance. When the ratio of change in output conductance is equal to the negative output conductance, the PV module will operate at the maximum power point.

The incremental conductance method exploits the assumption of the ratio of change in output conductance is equal to the negative output instantaneous conductance.

The power output of Photovoltaic cell is given by

$$P = IV \quad (9)$$

Applying the chain rule for the derivative of products of (9) yields

$$\frac{\partial P}{\partial V} = \frac{\partial(VI)}{\partial V} \quad (10)$$

at MPP then

$$\frac{\partial P}{\partial V} = 0 \quad (11)$$

Equations (10) and (11) can be simplified and written in terms of PV array voltage V and current I to give (12).

$$\frac{\partial I}{\partial V} = -\frac{I}{V} \quad (12)$$

The MPPT regulates the PWM control signal of the dc – dc converter until the condition in (13) is satisfied.

$$\left(\frac{\partial I}{\partial V}\right) + \left(\frac{I}{V}\right) = 0 \quad (13)$$

#### A. Flow Chart of Incremental Conductance Algorithm

The flow chart in Fig. 3 shows step by step on how Incremental Conductance technique is operating. Generally the technique follows the PV curve as shown in Fig. 2. When the previous sensed power (current x voltage) is less than the present sensed power it increases the voltage and when the previous sensed power is greater than the present sensed power it decreases the voltage while if the previous sensed power is equal to the present sensed power it maintains the operating voltage as demonstrated in Fig. 3.

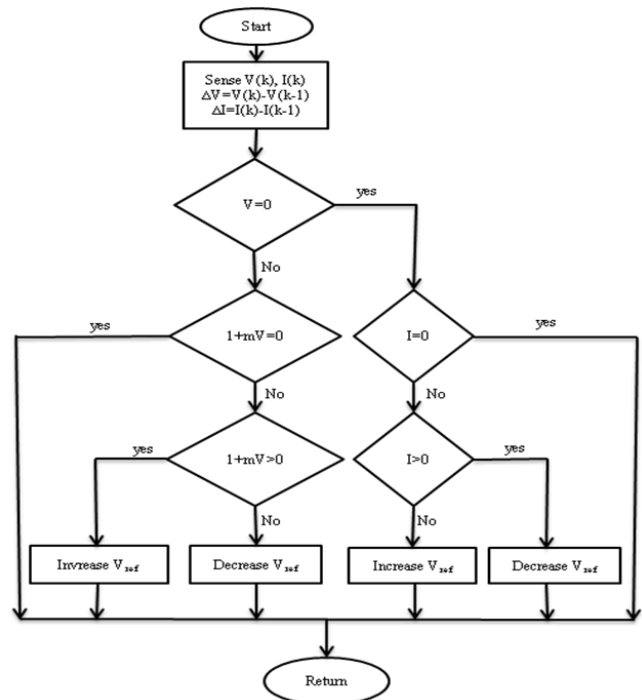

Fig. 3 Flowchart of incremental conductance algorithm for MPPT control where  $m = \frac{\Delta I}{\Delta V}$

#### B. DC-DC Converter for PV Application

A DC-DC converter is power electronic circuit which converts a source of direct current (DC) from one voltage level to another. It can have two distinct modes of operation: Continuous Conduction Mode (CCM) and Discontinuous Conduction Mode (DCM). In practice, a converter may operate in both modes, which have significantly different

characteristics. Therefore, a converter and its control should be designed based on both modes of operation. A dc-dc converter is normally used to control the PV voltage and current to the load.

C. Design of DC-DC Converter

The heart of MPPT hardware is a switch-mode dc-dc converter. It is widely used in DC power supplies and DC motor drives for the purpose of converting unregulated DC input into a controlled DC output at a desired voltage level. MPPT uses the same converter for a different purpose: regulating the input voltage at the PV MPP and providing load matching for the maximum power transfer. All Ćuk and SEPIC converters as shown in Figs. 4, 5 will operate at minimum values of parameters as shown in Table II.

TABLE II  
 ĆUK AND SEPIC DESIGN PARAMETERS

Component	Value	
	ĆUK	SEPIC
L1	5 mH	5 mH
C1	10 uF	10 uF
L2	2.5 mH	10 mH
C2	5 uF	100 uF

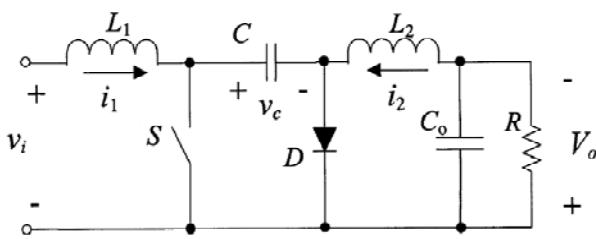

Fig. 4 Circuit diagram of Ćuk converter

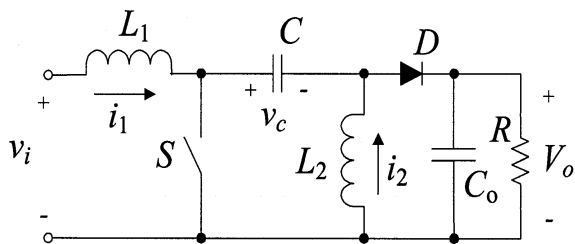

Fig. 5 Circuit diagram of SEPIC converter

V. COMBINED SYSTEM MODELING OF SEPIC AND ĆUK CONVERTERS

Modeling of the system by using Matlab/Simulink comprises of: Modeling of PV system according to (1) – (5), Modeling of MPPT control system based on the flow chart given in Fig. 3 and modeling of dc-dc converters based on the parameters given in Table II.

Fig. 6 shows the combined system modeled in such a way to compare two systems, the system with Ćuk converter and the system with SEPIC converter. The two systems are exposed under the same conditions (Temperature and irradiation) and also have the same PV parameters.

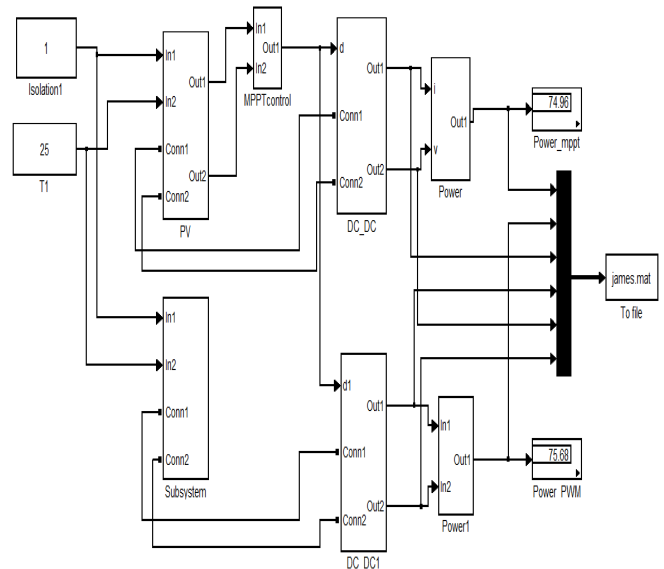

Fig. 6 Simulink Model for performance comparison between MPPT systems with Ćuk and with SEPIC dc-dc converters

VI. SIMULATION RESULTS AND DISCUSSIONS

Modeling and simulation of PV module and MPPT charger control was performed using MATLAB/SIMULINK software. Uniform irradiance and temperature is assumed for the PV module simulation.

The simulations were conducted stepwise with the changes of irradiance and temperature. The simulation results show that both systems with Ćuk converter and with SEPIC converter track the maximum power although with some variations as explained in (i) through (iii).

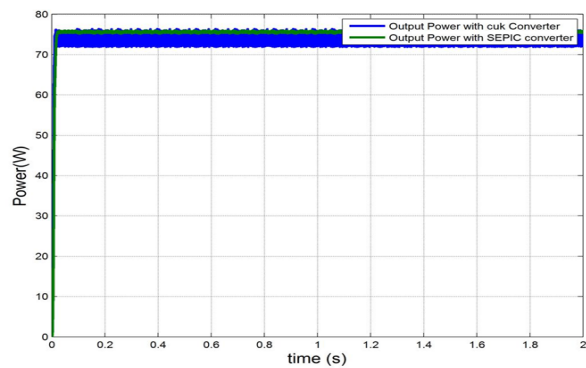

Fig. 7 Power at constant temperature of 25°C and constant irradiance of 1 kW/m²

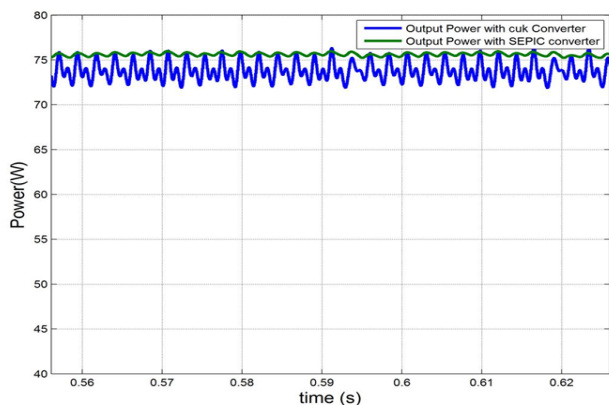

Fig. 8 Expanded time scale waveform of power at constant temperature of 25°C and constant irradiance of 1 kW/m<sup>2</sup>

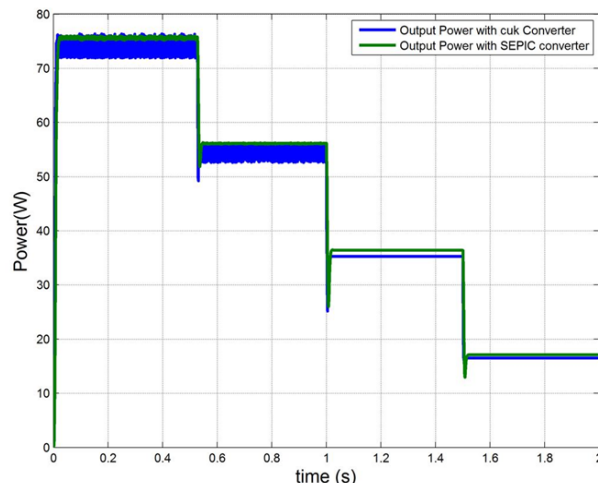

Fig. 11 Power at constant temperature of 25°C with step changes of irradiance

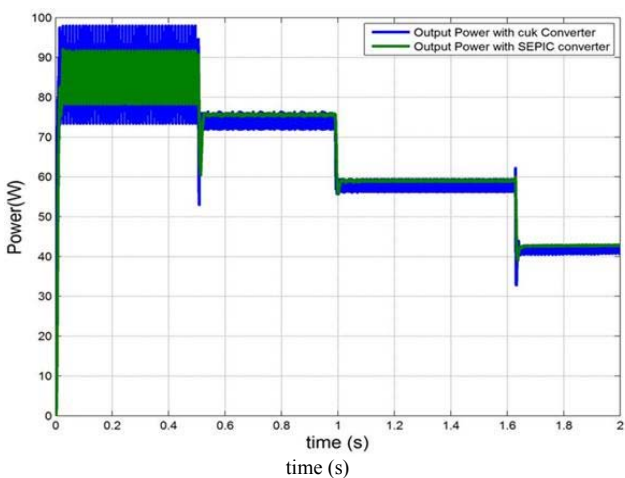

Fig. 9 Power at variation of temperature and constant irradiance of 1 kW/m<sup>2</sup>

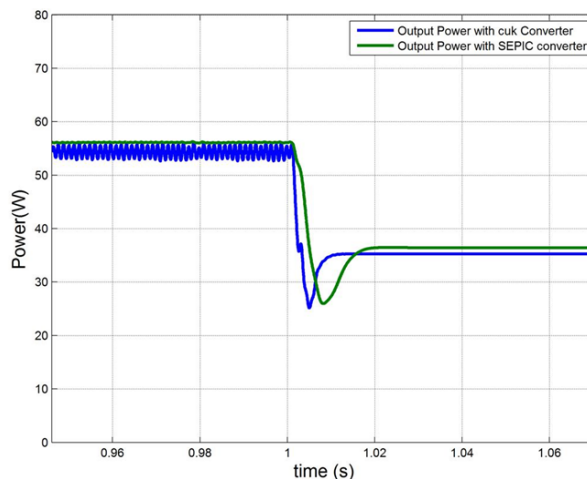

Fig. 12 Expanded time scale waveform of power at constant temperature of 25°C with a step change of irradiance from 0.75 kW/m<sup>2</sup> to 0.5 kW/m<sup>2</sup>

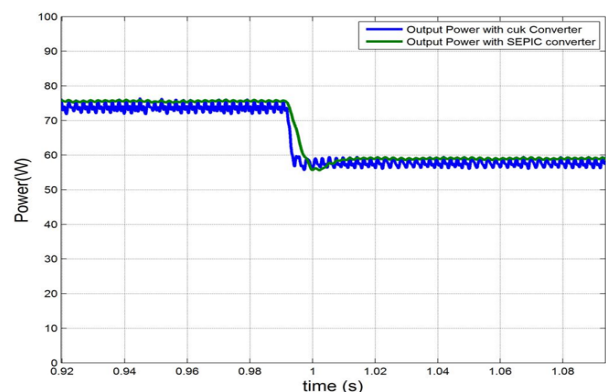

Fig. 10 Expanded time scale waveform of power for a step change of temperature from 25°C to 50°C and constant irradiance of 1 kW/m<sup>2</sup>

The simulation results depicted in Figs. 7 through 12 show that:

- (i) The MPPT with Ćuk converter track the maximum power point very fast compared to the system with SEPIC converter shown in Figs. 7 and 12.
- (ii) Output power from the system with Ćuk converter is not stable at maximum power as compared to the system with SEPIC converter, Figs. 7 through 12.
- (iii) All systems respond to the changes of temperature and irradiations, Figs. 9 through 12.

## VII. CONCLUSIONS

This study compares the performance of Ćuk and SEPIC converters used in MPPT design using incremental conductance technique. MATLAB/Simulink software has been used to simulate the system comprising Ćuk and SEPIC Converters.

The results show that all systems track the maximum power point although SEPIC is more stable with less power ripple as compared to Ćuk converter at maximum power output. On the other hand, the advantage of Ćuk converter is the reduction of circuit parameters (capacitor and inductance) as compared to SEPIC converter and hence reduced cost.

Selection of one converter from the two depends on the system requirements and budget. For good quality of output power, SEPIC converter is favorable while Ćuk converter offers low cost system.

#### ACKNOWLEDGMENT

The authors are grateful for financial support extended by Sida from Sweden.

#### REFERENCES

- [1] Aeronautics and Space Administration, (NASA-CR-149364) National Solar Cell Array Design Handbook, Vol.1, Jet Propulsion Lab, 1976.
- [2] K. H. Hussein, I. Muta, T. Hoshino, and M. Osakada, "Maximum photovoltaic power tracking: An algorithm for rapidly changing atmospheric conditions," *Proc. Inst. Elect. Eng., Generation, Transmission and Distribution*, Vol. 142, No. 1, January 1995, pp. 59–64.
- [3] K. Nishioka, N. Sakitani, Y. Uraoka, and T. Fuyuki, "Analysis of multi-crystalline silicon solar cells by modified 3-diode equivalent circuit model taking leakage current through periphery into consideration," *Solar Energy Materials and Solar Cells*, Vol. 91, No. 13, 2007, pp. 1222–1227.
- [4] M. R. Islam, R. Saidur, N. A. Rahim, and K. H. Solangi, "Usage of solar energy and its status in Malaysia," *Engineering e-Transaction*, Vol. 5, No. 1, 2010, pp. 6-10.
- [5] T. Eram and P. L. Chapman, "Comparison of photovoltaic array maximum power point tracking techniques," *IEEE Transactions on Energy Conversion*, Vol. 22, No. 2, June 2007, pp. 439–449.
- [6] N. Mohan, T. M. Undeland, and W. P. Robbins, *Power Electronics: Converters, Applications and Design*, Third Edition, John Wiley, New York, 2003.
- [7] M. H. Rashid, *Power Electronics, Circuits, Devices and Applications*, Third Edition, Prentice Hall, Upper Saddle River, NJ, 2004.